



H0, H0e, TT

Roco

EINSTEIGER PROGRAMM 2015

Starter Program 2015



**BASTELEN
BAUEN, TÜFTELN**
CREATE, BUILD, INVENT

FINGERFERTIGKEIT & KREATIVITÄT FÖRDERN
PROMOTE INNOVATIVE THINKING + COORDINATION



WELTEN ERKUNDEN
EXPLORE THE WORLD

GESCHICHTE, GEOGRAPHIE, ...
HISTORY, GEOGRAPHY, ...



LOKFÜHRER SEIN
BE A TRAIN DRIVER

FAHRGESCHICK BEWEISEN
SHOW DRIVING SKILL



**EINSTEIGEN!
CLIMB ABOARD!**

IST MODELLEISENBahn
IS MODEL RAILWAY



Entdecken Sie die faszinierende Welt der Modelleisenbahn

Herzlich Willkommen bei Roco! Erforschen Sie mit uns eines der kreativsten und spannendsten Hobbys. Mit unseren komplett spielfertigen Startsets können Sie einfach und schnell einsteigen und Schritt für Schritt Ihre Anlage ausbauen. Und mit dem genormten 2-Leiter-Gleichstromsystem kennen Sie keine Grenzen und fahren international.

Baugröße H0:

H0 ist die am weitesten verbreitete Größe im Maßstab 1 : 87 mit einem umfangreichen Angebot an Modellen und Zubehör.



Das Roco geoLINE Gleissystem:

Damit alles richtig läuft, steht Ihnen ein perfekt zugeschnittenes Gleissystem mit einem einfachen und klaren Systemraster zur Verfügung. Eine Vielfalt von geraden und gebogenen Gleisen, gerade Weichen und Bogenweichen, Kreuzungen, Dreiwegweichen oder flexible Gleise lassen beim Ausbau Ihrer Anlage keine Wünsche offen. Eine Erweiterung Ihrer Modellanlage ermöglichen zudem die praktischen Gleissets.

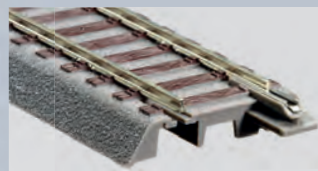

Das Roco geoLINE-Gleis mit vorbildgerechter Schotterbettung. Es ist leicht zusammensteckbar, hält fest zusammen und ist auch noch trittfest.

Enter the fascinating world of model trains

Roco welcomes you! Let's explore one of the most creative and exciting hobbies. With our ready-to-play starter sets you can enter the world of model trains in a very simple way and build your own railway layout step by step. With our standardized DC-System you there are no borders, so go ahead and drive internationally.

Scale H0:

H0 is the most common scale in size 1 : 87 with a wide range of models and accessories.



The Roco geoLINE track system:

For a smooth ride a perfectly tailored track system in a simple and clear track geometry is available. A variety of straight and curved tracks, straight and curved turnouts, crossings, three-way turnouts or flexible tracks leave nothing to be desired. A systematic expansion of your layout furthermore is possible with our handy track sets.

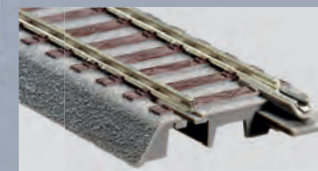

The Roco geoLINE track with realistic ballast bed. It simply clips into place and locks together tightly. You can even step on it.

Roco Kameraloks - Jetzt sind Sie mittendrin!

100 % Lokführerfeeling

Erleben Sie Ihre Anlage aus der Lokführerperspektive mit einer Kameralok: mit dem z21 System steuern Sie Ihre Modellbahn einfach mit Ihrem Smartphone oder Tablet-PC über Original Führerstände.

Roco camera locomotives - now you can be right in the thick of it!

Incredibly realistic: the ultimate train driving experience

Experience your layout from the train driver's perspective: with the z21 system you control your model trains simply via your smartphone or tablet PC from original driver's cab apps.



Steuern wie ein Lokführer

Unsere Modelle sind feine Hightech-Miniaturen. Durch die neueste Technik unter der „Haube“ ist Ihr Modellzug im Nu fahrbereit und mit z21 sogar über Ihr Smartphone oder Tablet-PC steuerbar.

Steuerungssysteme der Modellbahn:

Analog: Steuerung über einen elektronischen Fahrregler mit Steckernetzteil. Je weiter Sie den Fahrregler aufdrehen, desto schneller fährt die Lok. Ob beschleunigen oder bremsen, alle Loks auf der Anlage verhalten sich gleich. Keine individuellen Funktionen möglich.

Digital: Individuelle Steuerung mehrerer Loks gleichzeitig und unabhängig voneinander sowie Steuerung von Weichen und Signalen auf Ihrer Anlage.

Z. B. können Sie mit einer Lok rangieren, während Sie gleichzeitig einen Zug aus dem Bahnhof fahren lassen. Außerdem können Sie bei den Fahrzeugen individuelle Funktionen abrufen z. B. Originalsound, Licht ein-/ausschalten, Einstellung der Minimal-/Maximalgeschwindigkeit oder Anpassen des Bremsverhaltens.

Zum digitalen Fahren stehen Ihnen zwei Steuerungen zur Verfügung: ■ **multiMAUS** und ■ **z21**:

■ **Digitales Steuern mit der multiMAUS:**
Einfache Programmierung digitaler Funktionen



■ **Digitales Steuern mit z21 – die Modellbahnsteuerung der Zukunft Plug & Play-System**

Mit z21 steuern Sie sowohl Züge wie Weichen einfach mit Ihrem **Smartphone** oder **Tablet-PC**.



Ob eine oder mehrere Lokomotiven, ob Beleuchtung oder Bewegung auf der Modellbahnanlage – wie groß Sie Ihre Anlage auch ausbauen, mit der z21 Steuerzentrale aus einem Starter Set sind Sie für die Zukunft gerüstet!

Sie können auch über **fotorealistische Führerstände** Ihre Lokomotiven steuern und das sogar aus Kameralok-Perspektive – ganz wie ein echter Lokführer. Dazu stehen eine laufend erweiterte Anzahl an Führerständen zum Download bereit.

z21 – unbegrenzten Spielspaß für die ganze Familie!



z21 – Steuern aus Lokführerperspektive über fotorealistische Führerstände
z21 – Control from the view of the loco driver with photorealistic driver's cabs

z21 
www.z21.eu

Control like a locomotive driver

Our trains are highly detailed high-tech minatures. Due to the latest technology your train will be on track in a blink – with z21 even controllable via your smartphone or tablet PC.

Model railway control systems:

Analogue: Via an electronic controller and power plug. The more you turn on the controller, the faster the locomotive runs. No matter if you want the loco to accelerate or brake, all locos on the layout act in the same way. No individual functions are possible.

Digital: Individual control of several locos at once and independent of each other as well as switch signals and points.

This means, you are able to shunt a goods locomotive at the siding, while at the same time a passenger train is leaving the station. Besides this, you can control individual functions like original sound, switching lights on/off, control minimum/maximum speed or breaking inertia.

For your digital ride you can decide between two control systems: ■ **multiMAUS** und ■ **z21**:

■ **Digital control via multiMAUS:**
Easy programming of digital functions



■ **Digital control via z21 – the model railway control system of the future Plug & play system**

With z21 you can easily operate your trains and tracks from your **smartphone** oder **tablet PC**.



No matter whether you use one or several locomotives, control the lights or the traffic on your model railway layout, it can be extended according to your wishes. With the z21 model railway control system of a starter set you are always prepared for the future!

You also can operate your locos via **photorealistic driver's cabs** or even from your tablet PC. A continually expanded number of driver's cabs is available for download. z21 – unlimited game fun for the entire family!



z21 – alle Lokomotiven im Griff
z21 – every loco under control

Epochenerklärung / Epoch explanation

Ep I



Epoche I: Mit Inbetriebnahme der ersten Deutschen Eisenbahn, dem „Adler“, begann im Jahre 1835 die Epoche I der Eisenbahngeschichte. Dabei lackierten die verschiedenen Bahngesellschaften der einzelnen Länder ihre Fahrzeuge in unterschiedlichen Farben, was für bunte Züge auf den ersten Bahnstrecken sorgte.

Epoch 1: At the time of beginning operation of the first German railway, the „Eagle“ in 1835, the Epoch I of the railway history began. The various railway companies of the different countries painted their vehicles in different colours, which led to a colourful appearance of the trains on the first railway lines.

Epoche I / Epoch 1: ca. 1870 – 1920

Ep IV



Epoche IV: Ab ca. 1970 wurde in Europa ein neues Nummernsystem eingeführt, das alle Schienenfahrzeuge einheitlich kennzeichnen sollte. Dieses Nummernsystem kommt bis heute als „UIC-Nummernsystem“ zum Einsatz. Vor allem in Mitteleuropa prägten die TEE- sowie die InterCity-Züge das Bild der Bahnhöfe sowie Bahnstrecken. Gleichzeitig wurden auch die letzten verbliebenen Dampflokomotiven außer Betrieb gesetzt.

Epoch IV: Since about 1970, a new numbering system was introduced in Europe, which was supposed to designate all rail vehicles and standardize them. This „UIC numbering system“ is still in use until today. Especially in Central Europe the TEE and the intercity trains shaped the image of all stations and railway lines. At the same time the last remaining steam locomotives were decommissioned.

Epoche IV / Epoch IV: ca. 1965 bis 1990

Ep II



Epoche II: Vom Jahre 1920 bis ca. 1945/1950 dauerte die Epoche II bei der Eisenbahn. In Deutschland wird diese Epoche auch als „Reichsbahnzeit“ bezeichnet. Dabei erhielten die meisten Lokomotiven und Wagen eine einheitliche Lackierung. Gleichzeitig war dies die Blütezeit der großen, schweren Dampflokomotiven.

Epoch II: The Railway Epoch II lasted from 1920 until about 1945/1950. In Germany, this period is also known as the „Reichsbahnzeit“. The majority of locomotives and cars were given a standard livery. This was also the heyday of the big, heavy steam locomotives.

Epoche II / Epoch II: ca. 1920 – 1945/1950

Ep V



Epoche V: Ab ca. 1990 mit der Privatisierung vieler Bahngesellschaften und der Gründung neuer Privatbahnen wurde das Bild der Eisenbahn immer bunter. Diese Epoche dauerte bis in das Jahr 2005/06 an.

Epoch V: Starting about 1990, with the privatization of many railway companies and the establishment of new private railways the image of the railroad was becoming even more colourful. This epoch lasted until the year 2005/06.

Epoche V / Epoch V: 01.1994 bis 2006

Ep III



Epoche III: Bis in das Jahr 1970 waren in dieser Epoche viele vermischte Zuggarnituren unterwegs. Der Einsatz von alten Dampflokomotiven neben modernen Elektro- und Diesellokomotiven gehörte zum Alltag.

Epoch III: Until 1970 many mixed train sets were on the tracks of the railway lines during this period. The use of old steam locomotives in addition to modern electric and diesel locomotives were a part of the everyday life at that time.

Epoche III / Epoch III: ca. 1945 – 1970

Ep VI



Epoche VI: In der heutigen Epoche haben die privaten Eisenbahnverkehrsunternehmen einen großen Anteil am internationalen Bahnbetrieb. Im Personennahverkehr und im Güterverkehr kommen viele Lokomotiven und Waggons privater Bahngesellschaften zum Einsatz. Das UIC-Nummernschema wurde international aufgrund der vielen Schienenfahrzeuge unterschiedlicher Betreiber auf eine 12-stellige Kennzeichnung erweitert.

Epoch VI: In the today's epoch, the private railway companies play an essential role in the international railway traffic. In the passenger and freight transport many locomotives and wagons of private railway companies are used. The UIC numbering scheme was extended to a 12-digit identification internationally because of the many rail vehicles of different operators.

Epoche VI / Epoch VI: 2007 –

INHALT - CONTENTS

H0 Starter Sets	4
Next	16
H0 Modelle / H0 models	17-37
H0e Modelle / H0e models	37
TT Modelle / TT models	38
geoline Gleisssets / geoline track sets	40-42
geo line Gleise / geo line tracks	43-45

Zeichenerklärung / Legend

Art. Nr.: 00000	Artikelnummer / Article number		Gleichstrom mit Sound / Direct current DC w. sound
	Bahnverwaltung / Railway administration		Wechselstrom / Alternating current AC
Ep	Epoche / Epoch		Wechselstrom m. Sound / AC w. Sound
221	Länge über Puffer / Overall length		DCC (Digital ab Werk mit Decoder) / DCC (digital)
	Gleichstrom / Direct current DC		Schnittstelle 8 polig / 8 pole interface: NEM 652

Digital Starter Set: Diesellokomotive Rh 2045 + Güterzug, ÖBB

Digital Starter Set: Diesel locomotive series 2045 + freight train, ÖBB



Ep IV-V

Inhalt:

- 1 Diesellokomotive Rh 2045, ÖBB
- 1 Schiebewandwagen, 1 offener Güterwagen
- 1 Schwenkrungenwagen
- 1 x-Bus-Verstärker, 1 Steckernetzteil, 1 Handregler multiMaus

Roco geoLine-Gleisoval:

- 12 Bogen R3, 12 Gerade G200

Contents:

- 1 diesel locomotive series 2045, ÖBB
- 1 sliding wall wagon, 1 gondola
- 1 swing stake wagon
- 1 X-Bus amplifier, 1 plug-in power supply, 1 remote regulator multiMaus

Roco geoLine track oval:

- 12 curved tracks R3, 12 straight tracks G200

Art. Nr.: 51270

€ 219,00



Digital Starter Set: Elektrolokomotive Ee3/3 + Güterzug, SBB

Digital Starter Set: Electric locomotive Ee3/3 and freight train, SBB



Ep V

Inhalt:

- 1 Elektrolokomotive Ee3/3, SBB
- 1 offener Güterwagen, 1 Kesselwagen
- 1 gedeckter Güterwagen, 1 Rungenwagen
- 1 x-Bus-Verstärker, 1 Steckernetzteil, 1 Handregler multiMaus

Roco geoLine-Gleisoval:

- 12 Bogen R3, 17 Gerade G200, 1 Weiche links (mit elektr. Antrieb + Decoder), 1 Prellbock, 1 Böschungsendstück

Contents:

- 1 electric locomotive Ee3/3, SBB
- 1 gondola, 1 tank wagon
- 1 boxcar, 1 stake wagon
- 1 X-Bus amplifier, 1 plug-in power supply, 1 remote regulator multiMaus

Roco geoLine track oval:

- 12 curves R3, 17 straight tracks G200, 1 left turnout (turnout motor + decoder), 1 buffer stop, 1 track end piece

Art. Nr.: 41405

€ 349,00



Starter Sets

Digital Starter Set: Diesellokomotive T 679 + Kranzug, CSD

Digital Starter Set: Diesel locomotive T 679 + crane train, CSD



CSD

Ep IV

Inhalt:

- 1 Diesellokomotive T 679, CSD
- 1 Kranwagen
- 1 Schutzwagen
- 1 x-Bus-Verstärker, 1 Steckernetzteil, 1 Handregler multiMaus

Roco geoLine-Gleisoval:

- 12 Bogen R3, 12 Gerade G200

Contents:

- 1 diesel locomotive T 679, CSD
- 1 crane wagon
- 1 barrier wagon
- 1 X-Bus amplifier, 1 plug-in power supply, 1 remote regulator multiMaus

Roco geoLine track oval:

- 12 curved tracks R3, 12 straight tracks G200

Art. Nr.: 51272

€ 229,00



Digital-Starterset: Dampflokomotive BR 80 + Personenzug, DB / Digital Starter Set: Steam locomotive BR 80 and passenger train, DB



DB

Ep III

Inhalt:

- 1 Dampflokomotive BR 80, DB
- 2 Personenwagen
- 1 Handregler multiMaus
- 1 x-Bus-Verstärker, 1 Steckernetzteil

Roco geoLine-Gleisoval:

- 12 Bogen R3, 4 Gerade G200

Contents:

- 1 Steam locomotive BR 80
- 2 passenger carriages
- 1 remote regulator multiMaus
- 1 x-bus-amplifier, 1 plug-in power supply

Roco geoLine track layout:

- 12 curved tracks R3, 4 straight tracks G200

Art. Nr.: 51263

€ 159,00

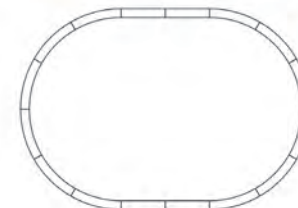

Digital Starter Set: BR 132 + Güterzug, DR

Digital Starter Set: BR 132 + freight train, DR



DR

Ep

IV

Inhalt:

- 1 Diesellokomotive BR 132, DR
- 3 Kesselwagen
- 1 x-Bus-Verstärker, 1 Steckernetzteil,
- 1 Handregler multiMaus

Roco geoLine-Gleisoval:

- 12 Bogen R3, 12 Gerade G200

Art. Nr.: 51271

€ 229,00

Contents:

- 1 diesel locomotive BR 132, DR
- 3 tank cars
- 1 X-Bus amplifier, 1 plug-in power supply,
- 1 remote regulator multiMaus

Roco geoLine track oval:

- 12 curved tracks R3, 12 straight tracks G200



Analog-Starterset: Elektrotriebzug ICE 2, DB AG

Analogue Starter Set: Electric Multiple Unit ICE2, DB AG



DB

Ep

V

Inhalt:

- 1 Elektrotriebzug ICE 2, DB AG
- 1 elektronischer Handregler
- 1 Steckernetzteil

Roco geoLine-Gleisoval:

- 12 Bogen R3, 8 Gerade G200,

Art. Nr.: 51153

€ 129,00

Contents:

- 1 multiple unit ICE 2, DB AG
- 1 electronic remote control
- 1 plug-in power supply

Roco geoLine track oval:

- 12 curved tracks R3, 8 straight tracks G200

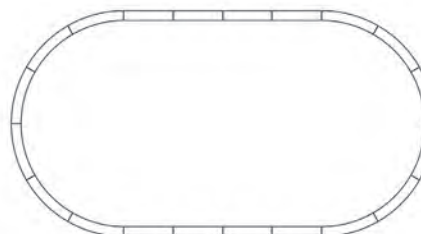

Starter Sets

Analog-Starterset: Diesellokomotive BR 290 + Güterzug, DB AG / Analogue Starter Set: Diesel locomotive BR 290 + freight train, DB AG



Ep

V

Inhalt:

- 1 Diesellokomotive BR 290, DB AG
- 1 offener Güterwagen
- 1 Niederbordwagen
- 1 elektronischer Handregler, 1 Steckernetzteil

Roco geoLine-Gleisoval:

- 12 Bogen R3, 2 Gerade G200



Art. Nr.: 51154

€ 99,00

Contents:

- 1 Diesel locomotive BR 290, DB AG
- 1 gondola
- 1 low sided car
- 1 electronic remote control, 1 plug-in power supply

Roco geoLine track oval:

- 12 curved tracks R3, 2 straight tracks G200

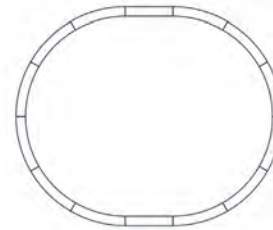

Digital Starter Set: ICE 2 und Diesellokomotive BR 218 DB AG + Güterzug / Digital Starter Set: ICE 2 and diesel locomotive series 218 DB AG, + freight cars



Ep

V-VI

Inhalt:

- 1 Elektrotriebzug ICE 2 der DB AG
- 1 Diesellokomotive BR 218
- 1 Schiebeplanenwagen, 1 Teleskophaubenwagen, 1 Niederbordwagen
- 1 x-Bus-Verstärker, 1 Steckernetzteil, 1 Handregler multiMaus

Roco geoLine-Gleisoval:

- 12 Bogen R3, 14 Gerade G200, 1 Weiche links,
- 1 Weiche rechts, 2 Gegenbogen, 4 Ausgleichsgerade



Contents:

- 1 three-part ICE2 of the DB AG
- 1 diesel locomotive series BR 218
- 1 sliding tarpoline car, 1 telescopic covered car, 1 gondola
- 1 x-bus-amplifier, 1 plug-in power supply, 1 remote regulator multiMaus

Roco geoLine track layout:

- 12 R3 curves, 14 G200 straight track elements, 1 left switch,
- 1 right switch, 2 dry arches, 4 clearing tracks

Art. Nr.: 51256

€ 299,00



Digital Star-Set ICE 2 Video-Cam, DB AG

Digital Starter Set: ICE 2 with camera locomotive, DB AG



Ep V-VI

Inhalt:

- 1 Elektrotriebzug ICE 2, DB AG
- 1 eingebaute Digi-Cam inkl. Sende-/Empfangsmodul
- 1 Steckernetzteil

Roco geoLine-Gleisoval:

- 12 Bogen R3, 8 Gerade G200



zusätzlich Smartphone od. Tablet-PC notwendig!

Contents:

- 1 multiple unit ICE 2, DB AG
- 1 built-in digi-cam incl. send/receiving unit
- 1 plug-in power supply

Roco geoLine track oval:

- 12 curved tracks R3, 8 straight tracks G200



Additional smart phone or tablet PC necessary



camera loco



Kameralok

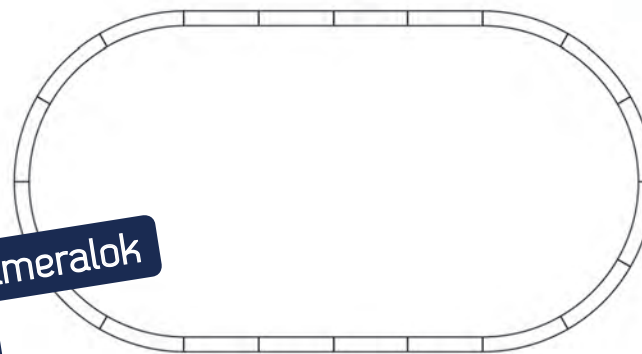

Starter Sets

Digital Starter Set z21: Elektrolokomotive BR 145 + Güterzug, DB AG

Digital Starter Set z21: electric locomotive series 145 + freight train, DB AG



Sound



Ep

VI

Inhalt:

- 1 Elektrolokomotive BR 145, DB AG
- 4 Schiebeplanenwagen
- 1 z21 Digitalzentrale mit WLAN
- 1 Steckernetzteil

Roco geoLine-Gleisoval:

- 12 Bogen R3, 12 Gerade G200



zusätzlich Smartphone od. Tablet-PC notwendig!



Contents:

- 1 electric locomotive BR 145, DB AG
- 4 sliding tarpaulin wagon
- 1 z21 digital model railway system with wireless LAN
- 1 plug-in power supply unit

Roco geoLine track oval:

- 12 curved tracks R3, 12 straight tracks G200



Additional smart phone or tablet PC necessary



Art. Nr.: 41514

€ 349,00

Analog Starterset: Diesellokomotive D.214 + Kranzug, FS

Analogue Starter Set: Diesel locomotive D.214 + crane train, FS



Ep IV

Inhalt:

- 1 Diesellokomotive D.214, FS
- 1 Kranwagen, 1 Schutzwagen, 1 Güterwagen
- 1 elektronischer Fahrregler, 1 Steckernetzteil

Roco geoLine-Gleisoval:

- 12 Bogen R3, 4 Gerade G200

Contents:

- 1 diesel locomotive D.214, FS
- 1 crane wagon, 1 barrier wagon, 1 freight car
- 1 electronic speed controller, 1 plug-in power supply unit

Roco geoLine track oval:

- 12 curved tracks R3, 4 straight tracks G200

Art. Nr.: 51157

€ 129,00

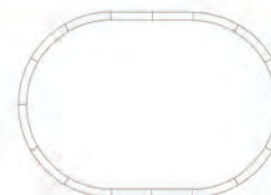

Digital Starter Set: Diesellokomotive K.211+ Güterzug, Serfer

Digital Starter Set: Diesel locomotive K.211 + freight train, Serfer



PRIVAT

Ep V

Inhalt:

- 1 Diesellokomotive K.211, Serfer
- 1 offener Güterwagen, 2 Spitzdachwagen
- 1 x-Bus-Verstärker, 1 Steckernetzteil, 1 Handregler multiMaus

Roco geoLine-Gleisoval:

- 12 Bogen R3, 12 Gerade G200

Contents:

- 1 diesel locomotive K.211, Serfer
- 1 gondola, 2 freight cars
- 1 x-Bus amplifier, 1 plug-in power supply unit, 1 remote regulator multiMaus

Roco geoLine track oval:

- 12 curved tracks R3, 12 straight tracks G200

Art. Nr.: 51280

€ 199,00



Starter Sets

Digital Starter Set: Diesellokomotive 602 + Güterzug, Railpro Digital Starter Set: Diesel locomotive 602 + freight train, Railpro



EINSTELLER

Ep VI

Inhalt:

- 1 Diesellokomotive 602, Railpro
- 3 Schotterwagen
- 1 x-Bus-Verstärker, 1 Steckernetzteil, 1 Handregler multiMaus

Roco geoLine-Gleisoval:

- 12 Bogen R3, 8 Gerade G200

Art. Nr.: 51278

€ 249,00

Contents:

- 1 diesel locomotive 602, Railpro
- 3 ballast cars
- 1 x-Bus amplifier, 1 plug-in power supply unit, 1 remote regulator multiMaus

Roco geoLine track oval:

- 12 curved tracks R3, 8 straight tracks G200

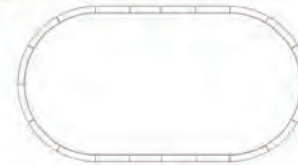

Digital-Startset: Diesellokomotive Di3 + Schnellzug, NSB / Digital Starter Set: Diesel locomotive Di3 + passenger train, NSB



Ep III-IV

Inhalt:

- 1 Diesellokomotive Di3, NSB
- 3 Schnellzugwagen
- 1 x-Bus-Verstärker, 1 Steckernetzteil, 1 Handregler multiMaus

Roco geoLine-Gleisoval:

- 12 Bogen R3, 12 Gerade G200

Art. Nr.: 51276

€ 289,00

Contents:

- 1 diesel locomotive Di3, NSB
- 3 passenger carriages
- 1 x-Bus amplifier, 1 plug-in power supply unit, 1 remote regulator multiMaus

Roco geoLine track layout:

- 12 curved tracks R3, 12 straight tracks G200



Digital-Starterset: Diesellokomotive BR 294 + Güterzug, PKP Cargo
Digital Starter Set: Diesel locomotive BR 294 + freight train, PKP Cargo



PKP

Ep V-VI

Inhalt:

- 1 Diesellokomotive BR 294, PKP Cargo
- 3 Teleskophaubenwagen
- 1 x-Bus-Verstärker, 1 Steckernetzteil, 1 Handregler multiMaus

Roco geoLine-Gleisoval:

- 12 Bogen R3, 12 Gerade G200

Art. Nr.: 51274

€ 199,00

Contents:

- 1 diesel locomotive BR 294, PKP Cargo
- 3 telescopic hood wagons
- 1 x-Bus amplifier, 1 plug-in power supply unit, 1 remote regulator multiMaus

Roco geoLine track oval:

- 12 curved tracks R3, 12 straight tracks G200



Digital Starter Set: Diesellokomotive T94 + Güterzug, SJ
Digital Starter Set: Diesel locomotive T94 + freight train, SJ



SJ

Ep V

Inhalt:

- 1 Diesellokomotive T94, SJ
- 3 Kugelsilowagen
- 1 x-Bus-Verstärker, 1 Steckernetzteil, 1 Handregler multiMaus

Roco geoLine-Gleisoval:

- 12 Bogen R3, 12 Gerade G200

Art. Nr.: 51279

€ 229,00

Contents:

- 1 diesel locomotive T94, SJ
- 3 silo-cars
- 1 x-Bus amplifier, 1 plug-in power supply unit, 1 remote regulator multiMaus

Roco geoLine track oval:

- 12 curved tracks R3, 12 straight tracks G200



Starter Sets

Digital Starter Set: Diesellokomotive D.340 + Stahlzug, RENFE

Digital Starter Set: Diesel locomotive D.340 + steel train, RENFE



Ep IV-V

Inhalt:

- 1 Diesellokomotive D.340, RENFE
- 2 Coilwagen, 1 Teleskophaubenwagen
- 1 x-Bus-Verstärker, 1 Steckernetzteil, 1 Handregler multiMaus

Roco geoLine-Gleisoval:

- 12 Bogen R3, 12 Gerade G200

Art. Nr.: 51269

€ 229,00

Contents:

- 1 diesel locomotive D.340, RENFE
- 2 wagons loaded with coils, 1 telescopic hood wagon
- 1 x-Bus amplifier, 1 plug-in power supply unit, 1 remote regulator multiMaus

Roco geoLine track oval:

- 12 curved tracks R3, 12 straight tracks G200



Digital-Starter Set H0e: Schlepptenderlokomotive + Personenzug / Digital Starter Set H0e: Steam locomotive with tender and passenger train

Ep III-IV

Inhalt:

- 1 Dampflokomotive
- 2 Personenwagen, 1 Gepäckwagen
- 1 x-Bus-Verstärker, 1 Steckernetzteil, 1 Handregler multiMaus

Roco geoLine-Gleisoval:

- 12 Bogen, 16 Gerade, 2 Handweichen links, 1 Handweiche rechts, 1 Ausgleichsbogen, 2 Ausgleichsgerade

Art. Nr.: 31028

€ 279,00

Contents:

- 1 steam locomotive
- 2 passenger carriages, 1 baggage car
- 1 x-Bus amplifier, 1 plug-in power supply unit, 1 remote regulator multiMaus

Roco geoLine track layout:

- 12 curved tracks, 16 straight tracks, 2 manual turnouts left, 1 manual turnout right, 1 adjustment curve, 2 adjustment straights



Digital Starterset: Diesellokomotive BR 132 + Güterzug, DR

Digital Starter Set: Diesel locomotive series 132 + freight train, DR



DR

Ep

IV

Inhalt:

- 1 Diesellokomotive BR 132, DR
- 3 Containertragwagen
- 1 x-Bus-Verstärker, 1 Steckernetzteil, 1 Handregler multiMaus

Das Set enthält keine Gleise!

Contents:

- 1 diesel locomotive series 132, DR
- 3 container carrier wagons
- 1 x-Bus amplifier, 1 plug-in power supply unit, 1 remote regulator multiMaus

Set does not include tracks!



Art. Nr.: 35013

€ 229,00

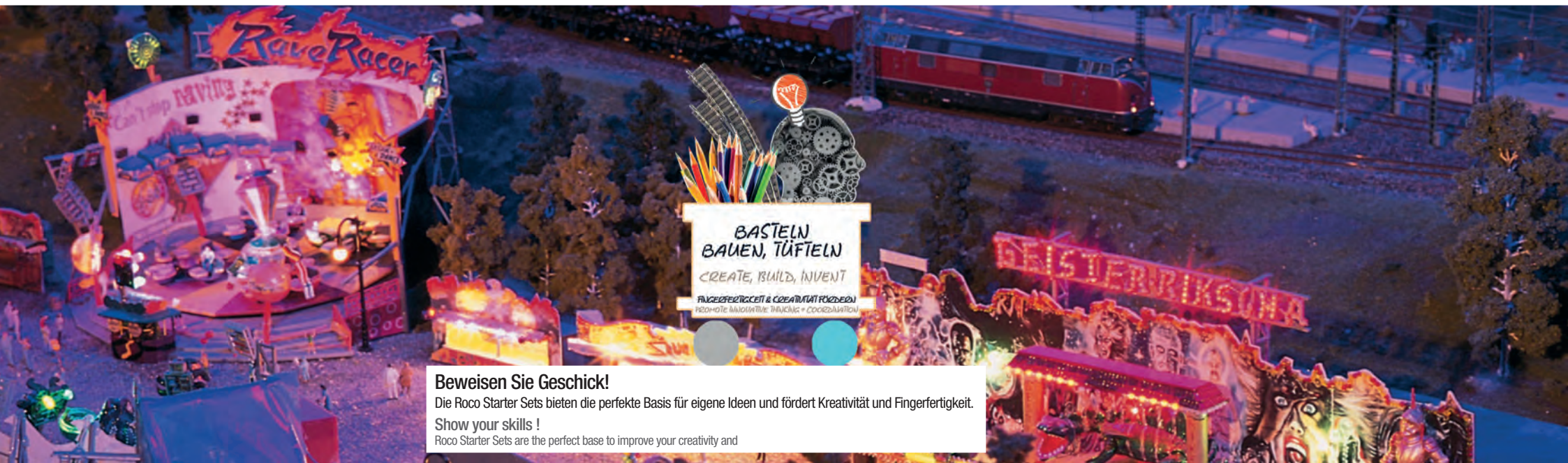

Beweisen Sie Geschick!

Die Roco Starter Sets bieten die perfekte Basis für eigene Ideen und fördert Kreativität und Fingerfertigkeit.

Show your skills!

Roco Starter Sets are the perfect base to improve your creativity and

Modellbahn & Game Fun wie nie!

Model railway and fun games like never before!



Für iOS und Android
For iOS and Android

Art.Nr. 51401

Basic Set

Detektiv Tom

Detective Tom

€ 149,-



Art.Nr. 51400

Basic Set

Fun Park

€ 149,-

Next Generation – Nachwuchsförderung der neuen Art! / Next Generation – a new way of developing young talent!

Roco hat die Modellbahn für Kinder neu erfunden! Über Tablet oder Smartphone (nicht enthalten) steuern Kinder ab 6 den Zug durch fantastische Abenteuergeschichten und erhalten dazu viele Bastelideen. So macht Einsteigen in unser Hobby noch mehr Spaß!

Roco has reinvented the model railway for children. Using a tablet or smartphone (not included), children aged six and above drive a train through amazing adventures and get lots of ideas for making things. This makes it even more fun for kids to get involved in our hobby.

- Spannende Spiele für Jung und Alt / Exciting games for young and old
- Auf Roco geoLine Gleisen – mit jeder H0 Gleichstromanlage kombinierbar / On Roco geoLine tracks – compatible with any H0 DC power system

Einfach auszubauen! / Easy to set up!

Mit den Aufbausets geht das Abenteuer weiter! Sie enthalten weitere Gleise und zwei neue Geschichten. Wer z.B. mit dem Basic Set „Fun Park“ beginnt, kann mit den Wechsel- und Wechselaufbausets auch alle „Detektiv Tom“ Abenteuer spielen. Und umgekehrt. / The adventure continues with our expansion sets! You get more tracks and two new stories. If you have started with the „Fun Park“ basic set, for example, you can play all the „Detective Tom“ adventures with our exchange sets and exchange expansion sets, and vice versa.

- | | | |
|--|-----------------|---------|
| ■ Next Generation Aufbausets A1 / Next Generation Expansion Set A1 „Freizeitpark“ | Art. Nr.: 51402 | € 29,90 |
| ■ Next Generation Aufbausets B1 / Next Generation Expansion Set B1 „Detektiv“ | Art. Nr.: 51403 | € 29,90 |
| ■ Next Generation Wechselsets / Next Generation Change Set „Detektiv“ „Detektiv“ | Art. Nr.: 51404 | € 39,90 |
| ■ Next Generation Wechselsets / Next Generation Change Set „Freizeitpark“ | Art. Nr.: 51405 | € 39,90 |
| ■ Next Generation Aufbau-Wechselsets / Next Generation Expansion Change Set „Detektiv“ | Art. Nr.: 51406 | € 19,90 |
| ■ Next Generation Aufbau-Wechselsets / Next Generation Expansion Change Set „Freizeitpark“ | Art. Nr.: 51407 | € 19,90 |

Dampflokomotive BR 80, DB / steam locomotive BR 80, DB



Ep III

111

NEM 652



Art. Nr.: 63338 € 74,00

Dampflokomotive Baureihe 80 der Deutschen Bundesbahn.
Steam locomotive series 80 of the German Federal Railway.

Dampflokomotive BR 057, DB / Steam locomotive, BR 057, DB



Ep IV

217

NEM 652



Art. Nr.: 52609 € 159,00

Dampflokomotive Baureihe 057 der Deutschen Bundesbahn.
Steam Locomotive, class 057 of the German Federal Railway.

Dampflokomotive BR 57, DR / Steam locomotive BR 57, DR



DR

Ep IV

217

NEM 652



Art. Nr.: 52603 € 159,00

Dampflokomotive Baureihe 57 der Deutschen Reichsbahn.
Steam locomotive series 57 of the Deutsche Reichsbahn.

Elektrolokomotive Be 4/6, SBB / Electric locomotive series Be 4/6, SBB



Ep III-IV

190

NEM 652



Art. Nr.: 73433 € 149,00

Art. Nr.: 79433 € 189,00

Elektrolokomotive Be 4/6 der Schweizerischen Bundesbahnen
Electric locomotive series Be 4/6 of the Swiss Federal Railways.

Einzelmodelle / Single models

Elektrolokomotive BR 111, DB / Electric locomotive BR 111, DB



Ep IV

190

NEM 652



Art. Nr.: 72298 = € 129,00

Art. Nr.: 78298 ~ € 169,00

Elektrolokomotive Baureihe 111 der Deutschen Bundesbahn in ozeanblau / beige Farbgebung.
Electric locomotive series 111 of the German Federal Railway in ocean blue and beige livery.

Elektrolokomotive BR 244, DR / Electric locomotive BR 244, DR



DR

Ep IV

176

NEM 652



Art. Nr.: 52541 = € 119,00

Elektrolokomotive Baureihe 244 der Deutschen Reichsbahn. In der DDR wurden die BR E 44 zur BR 244 umbenannt.
The last locomotives of the series E 44 that operated in the GDR were designated BR 244.

Elektrolokomotive BR 144, DB / Electric locomotive BR 144, DB



Ep IV

176

NEM 652



Art. Nr.: 52540 = € 119,00

Art. Nr.: 58540 ~ € 159,00

Die Baureihe E 44 stellte einen Meilenstein der deutschen E-Lokentwicklung dar und prägte den elektrischen Eisenbahnverkehr von 1932 bis in die 1980er-Jahre.

The series E 44 represented a landmark in the development of German electric locomotives and made a decisive impact on the railway traffic from 1932 until the 1980s.

Elektrotriebzug ICE 2, DB AG / Multiple Unit ICE 2, DB AG



Ep VI

NEM 652



742

■ Passende Ergänzungswagen unter Art. Nr. 54270 und 54271 erhältlich



■ Suitable supplement wagons can be purchased by ordering the items 54270 and 54271

Art. Nr.: 63088 DCC € 139,00

Elektrotriebzug ICE 2 der Deutschen Bahn AG, bestehend aus einem motorisiertem Triebkopf, einem Steuerwagen und einem Bordrestaurant-Zwischenwagen. Mit Decoder
Multiple Unit ICE 2 of the Deutsche Bahn AG that consists of one motorized traction unit, one driving trailer and one on-board restaurant- intermediate wagon. With decoder

Straßenbahn / Tramway

PRIVAT

Ep III-V

247

NEM 652



Art. Nr.: 52583



€ 99,00

Gelenktriebwagen 6-achsrig in rot/weißer Farbgebung. Unterflurantrieb auf ein Drehgestell, dadurch freie Durchsicht durch den Fahrgastraum mit Inneneinrichtung.

6-axle tramway in red and white livery. Underfloor drive mechanism and therefore an unobstructed view in the passenger compartment with interior design.

Straßenbahn / Tramway

PRIVAT

Ep III-V

247

NEM 652



Art. Nr.: 52582



€ 99,00

Gelenktriebwagen 6-achsrig in blau/weißer Farbgebung. Unterflurantrieb auf ein Drehgestell, dadurch freie Durchsicht durch den Fahrgastraum mit Inneneinrichtung.

6-axle tramway in blue and white livery. Underfloor drive mechanism and therefore an unobstructed view in the passenger compartment with interior design.

Schienenbus Rh 5081, ÖBB / Railbus series 5081, ÖBB



Sound



Ep IV

320

NEM 652



Art. Nr.: 52632



€ 149,00

Art. Nr.: 52633



€ 224,00

- Passender Beiwagen unter Art. Nr. 52641 erhältlich
- Suitable trailer can be purchased by ordering the item 52641

Schienenbus Reihe 5081 der Österreichischen Bundesbahnen.
Railbus series 5081 of the Austrian Federal Railways.

Einzelmodelle / Single models

Schienenbusbeiwagen Rh 7081, ÖBB / Railbus trailer series 7081, ÖBB



Ep IV

160



■ Passend zu Art. Nr. 52632/52633 ■ Suitable to item nr. 52632/52633

Art. Nr.: 52641 € 49,90

Schienenbusbeiwagen Reihe 7081 der Österreichischen Bundesbahnen.
Railbus trailer series 7081 of the Austrian Federal Railways.

Schienenbus BR 798 / 998, DB / Railbus series 798 / 998, DB



Ep IV

320

NEM 652



Art. Nr.: 52630 € 149,00

Art. Nr.: 52631 € 224,00

Schienenbus Baureihe 798 / 998 der Deutschen Bundesbahn.
Railbus series 798 / 998 of the German Federal Railway.

Diesellokomotive BR V200, DB / Diesel locomotive BR V 200, DB



Ep III

213

NEM 652



Art. Nr.: 72988 € 119,00

Art. Nr.: 78988 € 159,00

Diesellokomotive Baureihe V 200 der Deutschen Bundesbahn.
Diesel locomotive series V 200 of the German Federal Railway.

Diesellokomotive BR 132, DR / Diesel locomotive BR 132, DR



DR



Ep IV

239

NEM 652



Art. Nr.: 52502 € 104,00

Art. Nr.: 52503 € 179,00

Die Diesellokomotiven der BR 132 wurden ab 1970 aus der damaligen Sowjetunion in die DDR importiert.
The diesel locomotives of the series 132 were imported from the former Soviet Union.

Diesellokomotive BR 232, DB AG / Diesel locomotive BR 232, DB AG



Ep V

239

NEM 652



Art. Nr.: 52500 = € 99,00

Art. Nr.: 52501 = € 169,00

Art. Nr.: 58501 ~ € 169,00

Die als Baureihe 232 eingereichten Dieselloks der DB AG stammen aus der Lokomotivfabrik Woroschilowgrad (UA).
The diesel locomotive of the DB AG is classified as series 232 and came from the locomotive factory Woroschilowgrad (UA).

Diesellokomotive BR 364, DB AG / Diesel locomotive BR 364, DB AG



Ep VI

120

NEM 652



Art. Nr.: 52530 = € 104,00

Art. Nr.: 58530 ~ € 144,00

Diesellokomotive Baureihe 364 der Deutschen Bahn AG.
Diesel locomotive series 364 of the Deutsche Bahn AG.

Diesellokomotive BR 360, DB AG / Diesel locomotive BR 360, DB AG



Ep V

120

NEM 652

72999 u. 78999 mit Digital-Kupplung
72999 and 78999 with digital coupling

Art. Nr.: 72998 = € 99,00

Art. Nr.: 72999 DCC € 164,00

Art. Nr.: 78999 ~ € 164,00

Die BR 360 ist eine leistungsfähige Rangierlok, die bis heute im gesamten Bundesgebiet auf Rangierbahnhöfen anzutreffen sind. Art. Nr. 72999 & 78999 sind mit einer Digital-Kupplung ausgestattet.
The BR 360 is a powerful shunting locomotive, whose variants can be found on shunting stations throughout the country. Item Nr. 72999 & 78999 are Equipped with digital couplers.

Diesellokomotive MY, DSB / Diesel locomotive MY, DSB



Ep IV

218

NEM 652



Art. Nr.: 52614 = € 139,00

Art. Nr.: 52615 = € 214,00

Art. Nr.: 58615 ~ € 214,00

Diesellokomotive Reihe MY der dänischen Staatsbahn.
Diesel locomotive MY of the Danish State Railway.

Einzelmodelle / Single models

Diesellokomotive Y8400, SNCF / Diesel locomotive Y8400, SNCF



SNCF

Ep V

115



Art. Nr.: 52515



€ 69,00

Die Kleindiesellokomotiven wurden von Arbel Fauvet in den frühen 1990ern in ganz Frankreich ausgeliefert.

The small Diesel locomotives were delivered by Arbel Fauvet throughout France in the early 1990s.

Diesellokomotive D.214, FS / Diesel locomotive D.214, FS



Ep V

83



Art. Nr.: 52650



€ 75,00

Diesellokomotive D.214 der Italienischen Staatsbahn.

Diesel locomotive D.214 of the Italian State Railways.

Diesellokomotive M61.001, MAV / Diesel locomotive M 61.001, MAV



Ep V-VI

218

NEM 652



Sound

MUSEUMSAUSFÜHRUNG M61.001
MUSEUM-EDITION M61.001

Art. Nr.: 52618



€ 139,00

Art. Nr.: 52619



€ 214,00

Diesellokomotive M61.001 der Ungarischen Staatsbahn in Ausführung der aktuellen Museumslok.
Diesel locomotive M61.001 of the Hungarian State Railway in current museum look and design.

Diesellokomotive Serie 2200, NS / Diesel locomotive series 2200, NS



Ep IV

217

NEM 652



Art. Nr.: 52511



€ 89,00

Art. Nr.: 58511



€ 129,00

Diesellokomotive der Serie 2200 der Niederländischen Staatsbahn.

Diesel locomotive of the series 2200 of the Dutch State Railway.

Diesellokomotive Di5, NSB / Diesel locomotive Di5, NSB



Ep V

120

NEM 652

52533 u. 58533 mit Digital-Kupplung
52533 and 58533 with digital coupling



Art. Nr.: 52532



€ 104,00

Art. Nr.: 52533

DCC

€ 169,00

Art. Nr.: 58533



€ 169,00

Diesellokomotive Di5 der Norwegischen Staatsbahn. Art. Nr. 72999 & 78999 sind mit einer Digital-Kupplung ausgestattet.
Diesel locomotive Di5 of the Norwegian State Railway. Item Nr. 72999 & 78999 are equipped with digital couplers.

Diesellokomotive 309, RENFE / Diesel locomotive 309, RENFE



Ep V

115



Art. Nr.: 52516



€ 75,00

Diesellokomotive 309 der Spanischen Staatsbahn.
Diesel locomotive 309 of the Spanish State Railway.



Jetzt sind Sie mittendrin!

Now you can be right in the thick of it!

Roco Kameraloks – Fantastisch! Realistisch! Roco Camera Locos – Incredibly realistic!

Mit der Kameralok erleben Sie Ihre Anlage aus der Lokführerperspektive. Steuern Sie dazu mit Ihrem Tablet-PC Ihre Kameralok über einen fotorealistischen Führerstand. Generationen von Modellbahnern haben davon geträumt, ihre Anlage originalgetreu aus der Lokführerperspektive zu erleben und wie ein Lokführer im Führerstand zu steuern. Mit den Roco Kameraloks ist das nun möglich.

At the tablet PC you can operate your locomotives with photorealistic driver's cabs and execute the manual operations like a real locomotive driver. Generations of model railway enthusiasts have dreamed of it; and thanks to Roco's camera locomotives, those dreams have now come true. On every journey you will see your model railway like you've never seen it before...from the train driver's perspective!



 **Kameralok für 221**
camera loco for 221



- Nahezu unsichtbar eingebaute Kamera
- Kamera schwenkt bei Kurvenfahrten mit
- Live-Bildeinspielung auch auf Ihr Smartphone

- camera is virtually invisible
- when the train turns so does the camera and with it your view
- live stream onto your tablet or smartphone

Lesen Sie mehr dazu auf / more info at: www.z21.eu



WWW.ROCO.CC



Eurofima Schnellzugwagen 1. Kl., ÖBB

1st class eurofima passenger car, ÖBB

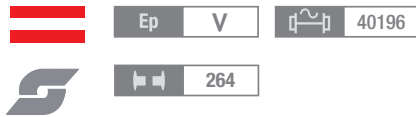

Art. Nr.: 54240

€ 24,90

■ Längenmaßstab 1:100 ■ in scale 1:100

Eurofima Schnellzugwagen 2. Kl., ÖBB

2nd class eurofima passenger car, ÖBB



Art. Nr.: 54241

€ 24,90

■ Längenmaßstab 1:100 ■ in scale 1:100

Speisewagen, ÖBB

Dining car, ÖBB

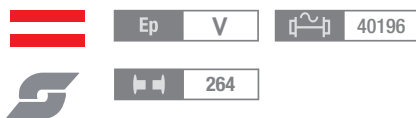

Art. Nr.: 54242

€ 24,90

■ Längenmaßstab 1:100 ■ in scale 1:100

Personenwagen 2. Kl., CSD

2nd class passenger carriage, CSD

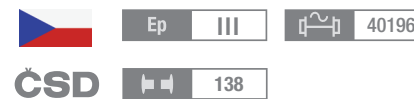

Art. Nr.: 54335

€ 18,40

Modell mit Kupplungsaufnahme nach NEM 362 und KK-Kinematik
Model with coupler pocket according to NEM 362 standards and close coupling mechanism.

Einzelmodelle / Single models

Personenwagen 2. Kl., DR 2nd class passenger carriage, DR

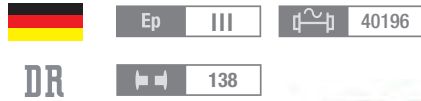

Art. Nr.: 54334 € 18,40

Modell mit Kupplungsaufnahme nach NEM 362 und KK-Kinematik
Model with coupler pocket according to NEM 362 standards and close coupling mechanism.

ICE-Zwischenwagen 1. Kl., DB AG 1st class ICE intermediate car, DB AG

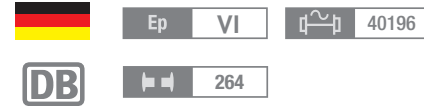

1:100



Art. Nr.: 54270 € 27,40

■ passend zu Art. Nr. 63088 ■ suitable for Item Nr. 63088

ICE-Zwischenwagen 2. Kl., DB AG 2nd class ICE intermediate car, DB AG

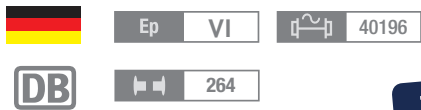

1:100



Art. Nr.: 54271 € 27,40

■ passend zu Art. Nr. 63088 ■ suitable for Item Nr. 63088

8-teiliges Set Güterwagen, ÖBB 8-piece set freight cars, ÖBB



Art. Nr.: 44006 € 54,00

8 unterschiedliche Güterwagen der ÖBB mit Kupplungsaufnahme nach NEM 362 und KK-Kinematik.
8 different models of the ÖBB with coupler pocket according to NEM 362 standards and close coupling mechanism.

Talbot-Schotterwagen, ÖBB

Talbot hopper car, ÖBB

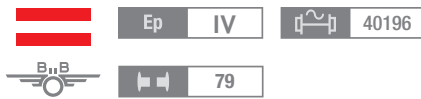

Art. Nr.: 56249

€ 14,90

Talbot-Schotterwagen der Österreichischen Bundesbahnen.
Talbot hopper car of the Austrian Federal Railways.

Gedeckter Güterwagen, CSD

Boxcar, CSD

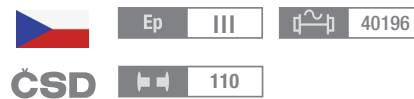

Art. Nr.: 56232

€ 16,90

Gedeckter Güterwagen der Tschechoslowakischen Staatsbahnen.
Boxcar of the Czechoslovakian State Railways.

Talbot-Schotterwagen, CSD

Talbot hopper car, CSD

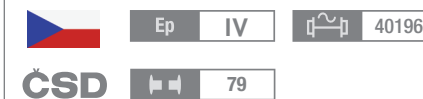

Art. Nr.: 56250

€ 12,90

Talbot-Schotterwagen der Tschechoslowakischen Staatsbahnen.
Talbot hopper car of the Czechoslovakian State Railways.

Offener Güterwagen, CD

Gondola, CD

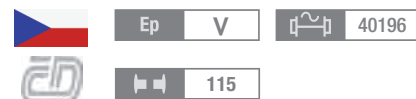

Art. Nr.: 56272

€ 12,40

Offener Güterwagen der Tschechischen Staatsbahn.
Gondola of the Czech State Railway.

8-teiliges Set Güterwagen, DRG

8-piece set freight cars, DRG



Art. Nr.: 44003

€ 54,00

8 unterschiedliche Güterwagen der Deutschen Reichsbahn Gesellschaft mit Kupplungsaufnahme nach NEM 362 und KK-Kinematik.
8 different freight cars of the German Reichsbahn Gesellschaft with coupler pocket according to NEM 362 standards and close coupling mechanism.

Einzelmodelle / Single models

8-teiliges Set Güterwagen, DB / 8-piece set freight cars, DB



Art. Nr.: 44002 € 54,00

8 unterschiedliche Güterwagen der Deutschen Bundesbahn mit Kupplungsaufnahme nach NEM 362 und KK-Kinematik.
8 different goods wagons of the German Federal Railway with coupler pocket according to NEM 362 standards and close coupling mechanism.

Talbot-Schotterwagen, DB

Talbot hopper car, DB

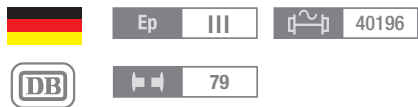

Art. Nr.: 56245 € 14,90

Talbot-Schotterwagen der Deutschen Bundesbahn.
Hopper car type Talbot of the Deutsche Bundesbahn.

8-teiliges Set Güterwagen, DR

8-piece set freight cars, DR



DR



Art. Nr.: 67127 € 54,00

8 unterschiedliche Güterwagen der Deutschen Reichsbahn mit Kupplungsaufnahme nach NEM 362 und KK-Kinematik.
8 different freight cars of the German Reichsbahn (GDR) with coupler pocket according to NEM 362 standards and close coupling mechanism.

Offener Güterwagen, DB

Gondola, DB

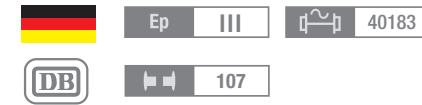

Art. Nr.: 46039 € 12,40

Offener Güterwagen der Deutschen Bundesbahn.
Gondola of the Deutsche Bundesbahn.

Go digital!

FLEISCHMANN

Roco



Live: Kameralok-Perspektive - camera loco view



Original Führerstand ICE BR 407 - original drivers cab BR 407



plug & play!



Z21)) Digitale Modellbahnsteuerung Z21 Z21 digital model railway control system

Einfacher geht's nicht! Mit dem revolutionären Z21 Plug & Play System steuern Sie Ihre gesamte Anlage inklusive Sound, Licht, Bewegung und alle digitalen Funktionen Ihrer Loks und Waggons einfach mit Ihrem Smartphone oder Tablet-PC. Damit können Sie Ihre Fahrzeuge wie ein echter Lokführer steuern! Lokkameras übertragen die Fahrt live auf Ihren Tablet-PC.

It couldn't be easier. With the revolutionary plug & play Z21 system you operate your entire railway layout including sound, light, movement on & off track (e.g. digital trains) via your smartphone and tablet PC. Now also with photorealistic driver's cabs of the original locomotives.

Z21 ist eine Entwicklung der Innovationsführer Fleischmann und Roco.
Z21 is a development of the innovation leaders Fleischmann and Roco.



Einzelmodelle / Single models

Gedeckter Güterwagen, DR

Boxcar, DR



Art. Nr.: 56234

€ 16,90

Gedeckter Güterwagen der Deutschen Reichsbahn.
Boxcar of the german federal railway.

Gedeckter Güterwagen, DB

Boxcar, DB



Art. Nr.: 56233

€ 16,90

Gedeckter Güterwagen der Deutschen Bundesbahn.
Boxcar of the german federal railway.

Kühlwagen, DB

Refrigerator car, DB



Art. Nr.: 56125

€ 12,40

Kühlwagen der Deutschen Bundesbahn.
Refrigerator car of the german federal railway.

Offener Güterwagen, DB

Gondola, DB



Art. Nr.: 56277

€ 11,90

Offener Güterwagen der Deutschen Bundesbahn.
Gondola of the german federal railway.

Rungenwagen, DB

Stake wagon, DB



Art. Nr.: 46031

€ 13,40

Rungenwagen der Deutschen Bundesbahn.
Stake wagon of the german federal railway.

Gedeckter Güterwagen, DR

Boxcar DR



Art. Nr.: 56069

€ 13,90

Güterwagen der Deutschen Reichsbahn mit braunem Rahmen.
Boxcar of the Deutsche Reichsbahn with brown frame.

Gedeckter Güterwagen, DR

Boxcar, DR

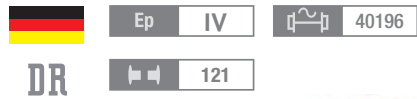

Art. Nr.: 56068

€ 13,90

Güterwagen der Deutschen Reichsbahn mit schwarzem Rahmen.
Boxcar of the Deutsche Reichsbahn with black frame.

Niederbordwagen, DR

Gondola, DR

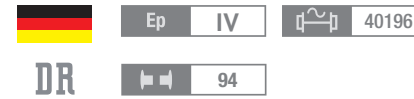

Art. Nr.: 56017

€ 9,90

Niederbordwagen der Deutschen Reichsbahn.
Gondola of the Deutsche Reichsbahn.

Talbot Schotterwagen, DR

Talbot hopper car, DR

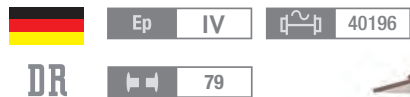

Art. Nr.: 56247

€ 14,90

Talbot-Schotterwagen der Deutschen Reichsbahn.
Talbot hopper car of the Deutsche Reichsbahn.

Talbot-Schotterwagen, DB AG

Talbot hopper car, DB AG

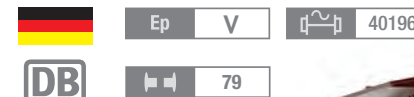

Art. Nr.: 56246

€ 14,90

Talbot-Schotterwagen der Deutschen Bahn AG.
Talbot hopper car of German federal railway.

Einzelmodelle / Single models

Kesselwagen GATX / Tank car, GATX



Ep VI

40196

EINSTELLER

102



Art. Nr.: 56260

€ 17,90

Kesselwagen der Firma GATX.
Tank car of the company GATX.

Gedeckter Güterwagen, DSB / Boxcar, DSB



Ep IV

40196

121

DSB



Art. Nr.: 56300

€ 16,90

Gedeckter Güterwagen der Dänischen Staatsbahn.
Boxcar of the Danish State Railway.

Gedeckter Güterwagen, SNCF

Boxcar, SNCF



Ep III

40196



107



Art. Nr.: 56230

€ 16,90

Gedeckter Güterwagen der Französischen Staatseisenbahn.
Boxcar of the French State Railway.

Offener Güterwagen, SNCF

Gondola, SNCF



Ep III

40196



97



Art. Nr.: 56281

€ 11,90

Offener Güterwagen der Französischen Staatseisenbahn.
Gondola of the French State Railway.

Offener Güterwagen, SNCF

Gondola, SNCF

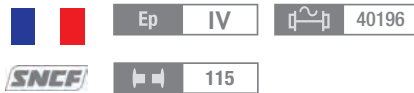

Art. Nr.: 56267

€ 12,40

Offener Güterwagen der Französischen Staatsbahn.
Gondola of the French State Railway.

Kleinviehwagen, MAV

Stock car, MAV

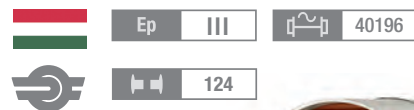

Art. Nr.: 56190

€ 14,90

Transportwagen für Kleinvieh der Ungarischen Staatsbahn.
For the transportation of small livestock of the Hungarian State Railway.



Offener Güterwagen, MAV

Gondola, MAV

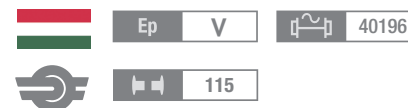

Art. Nr.: 56270

€ 12,40

Offener Güterwagen der Ungarischen Staatsbahn.
Gondola of the Hungarian State Railway.

Einzelmodelle / Single models

Gedeckter Güterwagen, FS

Boxcar, FS

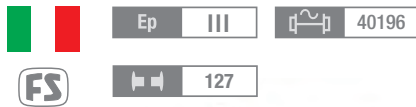

Art. Nr.: 47526

€ 12,90

Gedeckter Güterwagen mit Spitzdach der Italienischen Staatseisenbahn.
Box car with pointed roof of the Italian State Railway.

Gedeckter Güterwagen, FS

Boxcar, FS

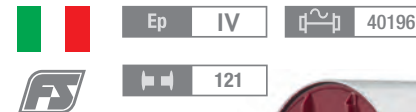

Art. Nr.: 56301

€ 16,90

Gedeckter Güterwagen mit Plattenwänden der Italienischen Staatsbahn.
Boxcar with slab walls of the Italian State Railway.

Gedeckter Güterwagen, FS

Boxcar, FS

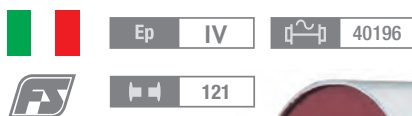

Art. Nr.: 56302

€ 16,90

Gedeckter Güterwagen mit Holzwänden der Italienischen Staatsbahn.
Boxcar with wooden walls of the Italian State Railway.

Talbot-Schotterwagen, FS

Talbot hopper car, FS

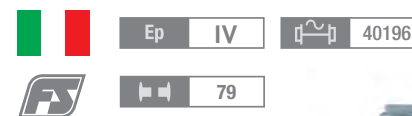

Art. Nr.: 56251

€ 12,90

Talbot-Schotterwagen der Italienischen Staatsbahn.
Talbot hopper car of the Italian State Railway.

Offener Güterwagen mit Kohle, FS

Gondola that carries coal, FS



Art. Nr.: 56273

€ 18,90

Offener Güterwagen der Italienischen Staatsbahn beladen mit Kohle.
Gondola of the Italian State Railway that carries coal.

Kesselwagen VTG, FS

Tank car VTG, FS



Art. Nr.: 56261

€ 17,90

Kesselwagen VTG, eingestellt bei der Italienischen Staatsbahn.
Tank car VTG hired out to the Italian State Railway.

Gedeckter Güterwagen, CFL

Boxcar, CFL



Art. Nr.: 67459

€ 14,90

Gedeckter Güterwagen der Luxemburgischen Staatsbahn.
Boxcar of the Luxemburgian State Railway.

Gedeckter Güterwagen, NS

Boxcar, NS



Art. Nr.: 67461

€ 16,90

Gedeckter Güterwagen der Niederländischen Staatsbahnen.
Boxcar type GS 1 of the Dutch State Railway.

Einzelmodelle / Single models

8-teiliges Set Güterwagen, NS

8 piece set freight cars, NS



Art. Nr.: 67128

€ 54,90

8 unterschiedliche Güterwagen der Niederländischen Staatsbahn mit NEM-Schacht und Kinematik für Kurzkupplung.

8 different goods wagons of the Dutch State Railway with coupler pocket according to NEM 362 standards and close coupling mechanism.

Offener Güterwagen, NS

Gondola, NS

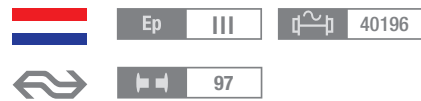

Art. Nr.: 56280

€ 11,90

Offener Güterwagen der Niederländischen Staatsbahn.

Gondola of the Dutch State Railway.

Offener Güterwagen, PKP

Gondola, PKP

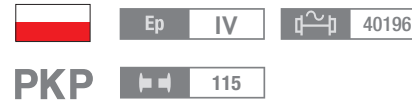

Art. Nr.: 56269

€ 11,90

Offener Güterwagen der Polnischen Staatsbahn.

Gondola of the Polish State Railway.

Talbot-Schotterwagen PKP

Talbot hopper car, PKP



Art. Nr.: 56244

€ 14,90

Schotterwagen Talbot der Polnischen Staatsbahn.

Talbot hopper car of the Polish State Railways.

Kesselwagen „Campsa“, RENFE

Tank car „Campsa“, RENFE



Art. Nr.: 56262

€ 17,90

Kesselwagen „Campsa“, eingestellt bei der Spanischen Staatsbahn.

Tank car „Campsa“ hired out to the Spanish Railways.

H0e: Feldbahn Diesellokomotive „Leo“

H0e: Light railway diesel locomotive „Leo“



Art. Nr.: 33209



€ 53,90

Feldbahn Diesellokomotive „Leo“. Antrieb auf alle drei Achsen.

Light railway Diesel locomotive „Leo“. Drive on all three axes.

H0e: 2-teiliges Set Kipploren

H0e: 2 piece set side tipping wagons



Art. Nr.: 34498

€ 13,40

H0e: 2-teiliges Set Kohlenloren

H0e: 2 piece set side tipping wagons



Art. Nr.: 34499

€ 13,40

Einzelmodelle / Single models

Diesellokomotive BR 232, DB AG / Diesel locomotive series 232, DB AG



Ep V

147

NEM 651



Art. Nr.: 36215



€ 104,00

Die als Baureihe 232 eingereichten Dieselloks der Deutschen Bahn AG stammen aus der Lokomotivfabrik Woroschilowgrad (UA).
Diesel locomotive series 232 of the Deutsche Bahn AG were delivered from the locomotive factory Woroschilowgrad (today's Ukraine).

Schwerlastwagen, DR / Heavy duty flat wagon, DR



Ep IV

DR

90



Art. Nr.: 37592

€ 16,90

Schwerlastwagen der Deutschen Reichsbahn.
Heavy duty flat wagon of the Deutsche Reichsbahn.

FLEISCHMANN

Roco

Loks und Wagen versandkostenfrei
nach Deutschland und Österreich
Free delivery on all locomotive and wagon
orders to germany and austria



Hier kommt Freude ins Haus! e-Shop und Ersatzteilservice von Fleischmann und Roco

Mit dem Ersatzteilservice ist jedes Teil einfach bestellt. Die Lieferung erfolgt prompt, wie Sie es wünschen, zu Ihnen nach Hause oder zu Ihrem Fachhändler.

Klicken Sie sich ein auf www.fleischmann.de und www.roco.cc

This is where the fun starts!

Online shop and spare parts service Fleischmann and Roco

Our spare parts portal offers a quick and easy service for spare parts of any kind. Delivery is prompt and your spare parts can be shipped directly to your home or to your specialized dealer.

For additional information simply click here www.fleischmann.de and www.roco.cc

geoLine GLEISSETS / geoLine TRACK SETS

geoLine-Gleissets: Erweiterung eines Gleisovals A / geoLine Track sets: extension of a track oval A

geoLine Gleisset B Track set B

Art. Nr.: 61101
€ 49,90

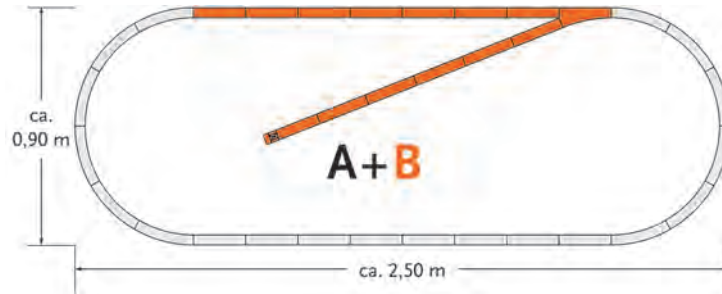

Inhalt: 13x Geraden G200 (61110), 1x Handweiche links (61140), 1x Prellbock (42608), 1x Bettungsendstück (61180); Platzbedarf ca. 250 x 90 cm

Contents: 13 straight tracks G200 (61110), 1 manual turnout left (61140), 1 buffer stop (42608), 1 roadbed end piece (61180). Space required: approx. 250 x 90 cm

geoLine Gleisset C Track set C

Art. Nr.: 61102
€ 65,00

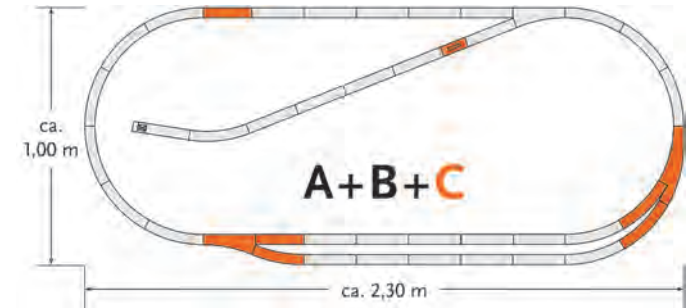

Inhalt: 2x Geraden G185 (61111), 2x Bogen R3 (61123), 1x Handentkupplungsgleis (61119), 1x Handbogenweiche rechts (61155), 1x Handweiche rechts (61141), 1x Gegenbogen (61128); Platzbedarf 230 x 100 cm

Contents: 2x straight tracks G185 (61111), 2x curves R3 (61123), 1x manual uncoupler track (61119), 1x manual curved turnout, right (61155), 1x manual turnout, right (61141), 1 complementary curve (61128). Space required: approx. 230 x 100 cm

geoLine Gleisset D Track set D

Art. Nr.: 61103
€ 114,00

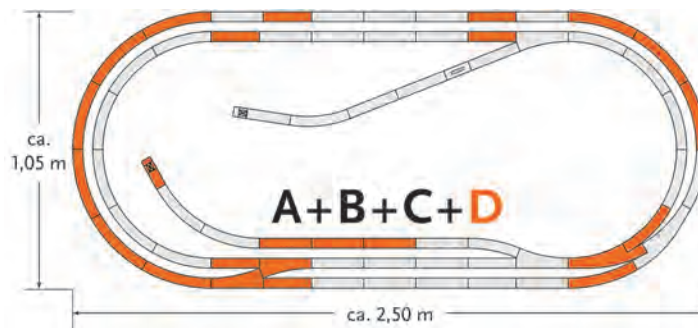

Inhalt: 3x Gerade G200 (61110), 6x Gerade G185 (61111) 1x Gerade G100 (61113), 1x Bogen R3 (61123), 10x Bogen R4 (61124), 2x Handweichen links (61140), 1x Handbogenweiche links (61154), 1x Prellbock (42608), 1x Bettungsendstück (61180); Platzbedarf ca. 243 x 106 cm

Contents: 3x straight tracks G200 (61110), 6x straight tracks G185 (61111) 1x straight tracks G100 (61113), 1x curve R3 (61123), 10x curves R4 (61124), 2x manual turnout, left (61140), 1x manual curved turnout, left (61154), 1x buffer stop (42608), 1x roadbed end piece (61180); Space required: approx. 243 x 106 cm

geoLine Gleisset E Track set E

Art. Nr.: 61104
€ 94,00

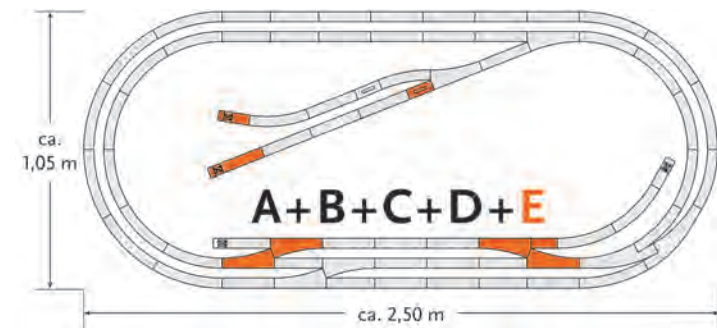

Inhalt: 1x Gerade G200 (61110), 2x Gerade G100 (61113), 2x Handweichen links (61140), 2x Handweichen rechts (61141), 2x Prellböcke (42608), 1x Handentkupplungsgleis (61119), 2x Bettungsendstücke (61180); Platzbedarf ca. 243 x 106 cm

Contents: 1x straight track G200 (61110), 2x straight tracks G100 (61113), 2x manual turnout, left (61140), 2x manual turnout, right (61141), 2x buffer stops (42608), 1x manual uncoupler track (61119), 2x roadbed end pieces (61180); Space required: approx. 243 x 106 cm

Erweiterung von Digital Starter Sets ... Extension of digital starter sets ...

Gleisplan eines
digitalen Startsets /
Track layout of a
digital starter set

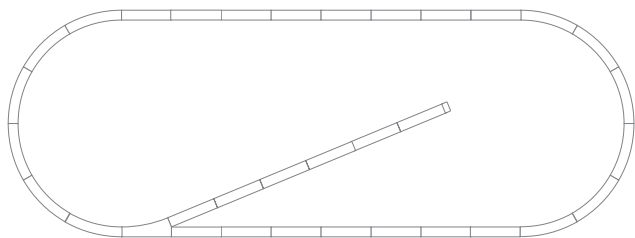

... mit den geoLine Gleis-Ergänzungssets für digitale Starter Sets / ... with the geoLine track extension sets for digital starter sets

Die perfekte Erweiterung!
The perfect complement!

Preisvorteil
Price advantage

Gleis-Ergänzungssets für Digital Starter Sets
zur digitalen Steuerung von Weichen / Entkupplungsgleisen

Track extension sets for digital starter sets for digital operation of turnouts / uncoupler tracks

Art. Nr.: 51250

€ 199,00

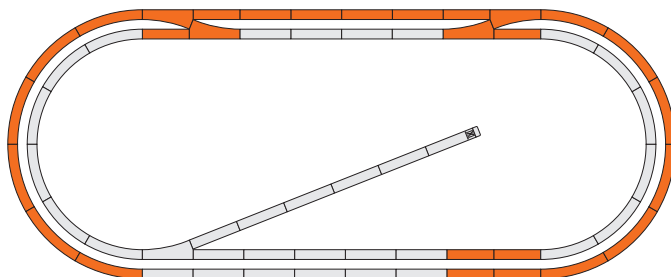

Ergänzungsset 1: Erstellen eines Parallelkreises

Inhalt:

4 Gerade G200 (61110), 8 Gerade G185 (61111), 12 Bogen R4 (61124),
2 Weichen links (61140) / 2 Weichen rechts (61141), jeweils mit el. Antrieben und Weichendecodern.
5x el. Weichenantriebe und 5x Weichendecoder zum Nachrüsten für digitale Starter Sets.
Anlagengröße ca. 263 x 106 cm

Set 1: to create a parallel circle

Contents:

4 straight tracks G200 (61110), 8 straight tracks G185 (61111), 12 curves R4 (61124),
2 turnouts left (61140) / 2 turnouts right (61141), each with el. turnout motor and decoder.
5x el. turnout motors and 5x turnout decoder to upgrade digital starter sets.
Size of layout approx. 263 x 106 cm

Art. Nr.: 51251

€ 199,00

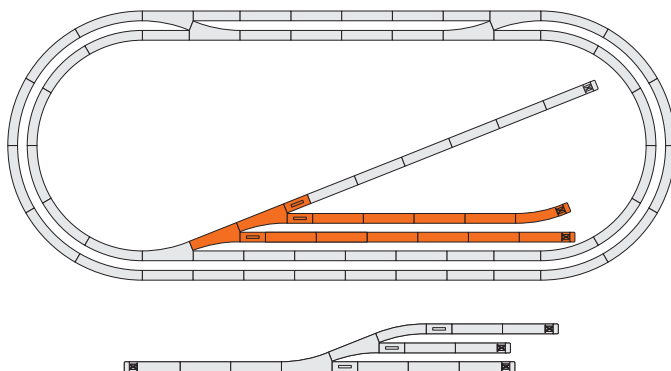

Ergänzungsset 2: Ergänzung zu 51250 zur Erstellung einer Abstellgruppe

10 Gerade G200 (61110), 1 Gegenbogen (61128),
2 Weichen rechts (61141) mit el. Antrieben und Weichendecodern.
3x el. Entkupplungsgleis (61118) mit eingebauten Decodern.
3x Prellbock (42608), 3 Bettungsendstücke (61180).
Anlagengröße ca. 263 x 106 cm

Set 2: extension to 51250 to create sidings

10 straight tracks G200 (61110), 1 complementary curve (61128),
2 turnouts right (61141), each with el. turnout motor and decoder.
3x el. uncoupler tracks (61118) with inbuilt decoder.
3x buffer stops (42608), 3 roadbed end pieces (61180).
Size of layout approx. 263 x 106 cm

geoLine GLEISE / geoLine TRACKS



Das Roco geoLine Gleis

Technik:

- Fahren mit dem international weit verbreitetem 2-Leiter-Gleichstromsystem
- Ideale Stromleiteigenschaften durch Vollprofilschienen aus einer hochwertigen Neusilberlegierung

Das Gleis:

- Realistisches Aussehen
- Sichere und stabile Verbindung der Gleise, einfacher Zusammenbau
- Robust und trittfest durch stabiles Schotterbett aus Kunststoff
- Schallgedämpft
- Günstiger Preis

Die Gleisgeometrie:

- Einfacher, übersichtlicher Systemraster
- Alle Weichen sind nachträglich auf elektrische Fernbedienung umrüstbar

The Roco geoLine track

Technology:

- Running with the internationally widespread 2-wire DC system
- Ideal current carrying capacity even on solid profile rails made of high quality nickel silver alloy.

The track:

- Realistic appearance
- Secure and stable connection to the tracks, easy assembly
- Robust and crush resistant plastic ballast bed
- Silenced
- Available at a convenient price

The track geometry:

- Easy and clear grid system
- All switches can be retrofitted for electrical remote control at a later date



Das geoLine Gleis: Robust und trittfest /
The geoLine track: is of a robust
construction and crush resistant

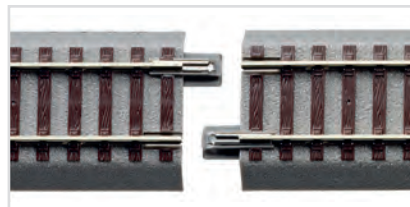

Sichere und stabile Verbindung der Gleise /
Secure and stable connection to the tracks

Gerade Gleise / Straight tracks

Art. Nr.: 61106 € 14,90

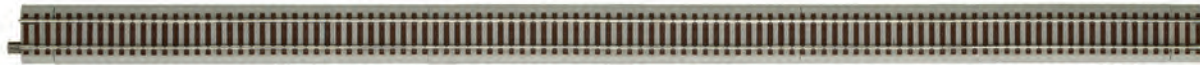

Art. Nr.: 61183 € 12,40



Set: Schwellenendstücke. Zum Ausgleich von Längendifferenzen bei Flexgleis 61106.
Inhalt 6 Endstücke, 12 Schienenverbinder, 1 Universalwerkzeug.
Set of sleeper end pieces. Used to equalise differences in length of the flex track 61106.
Content: 6 end pieces, 12 rail joiners, 1 universal tool.

Art. Nr.: 61110 € 2,60



Gerade G200, Länge 200 mm (Standardlänge)
Straight track G200, length 200 mm (standard length)

Art. Nr.: 61111 € 2,70



Gerade G185, Länge 185 mm.
Ausgleichsgerade zu den 22,5°-Weichen
Straight track G185, length 185 mm.
Adapter track for 22,5° turnouts

Art. Nr.: 61113 € 2,50



Gerade G100, Länge 100 mm (halbe Standardlänge)
Straight track G100, length 100 mm (half standard length)

Art. Nr.: 61112 € 2,60



Ausgleichsgerade G76,5, Länge 76,5 mm
Adapter straight track G76,5, length 76,5 mm

Art. Nr.: 61119 € 11,40



Hand-Entkupplungsgleis, Länge 100 mm.
(Kann nicht mit einem elektrischen Antrieb nachgerüstet werden)
Manual uncoupler track, length: 100 mm (cannot be retrofitted for electric operation)

Art. Nr.: 61118 € 27,90



Elektrisches Entkupplungsgleis, Länge 100 mm, mit elektrischem Antrieb
Electric uncoupler track, length: 100 mm, with electric motor

Art. Nr.: 61117 € 21,90



Schaltgleis, Länge 100 mm. Löst beim Befahren einen Schaltimpuls aus. Mit Prellschutz und Entstörung zur Vermeidung von Schaltspitzen. / **Switching track,** length 100 mm.
Triggers off a switching impulse when driving. Equipped with bounce protection and fault clearance to avoid switching spikes.

Art. Nr.: 61120 € 2,90



Übergangsgleis G100 zwischen geoLine Gleisen und Roco LINE-Gleisen, Länge 100 mm. / **Adapter track G100** between geoLine tracks and Roco LINE tracks, length: 100 mm

Flexgleis G800, Länge 785 mm. Zum Ausgleich von Längendifferenzen Set 61183 Schwellenendstücke verwenden.

Flexible track G800, length 785 mm. To equalise differences in length, use set of sleeper end pieces 61183.

Die geoLine Gleisgeometrie The geoLine track geometry

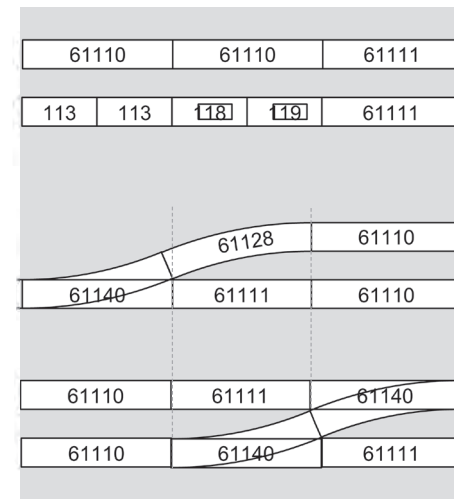

geoLine Gerade G185
Ausgleichsgerade zu den 22,5°-Weichen
geoLine geometry G185
Adapter track for turnouts 22,5°

Zubehör / Accessories

Art. Nr.: 61180 € 6,90



Bettungsendstück. Zur Ermöglichung eines sauberen Abschlusses bei Prellböcken, Vitrinengleisen, etc. 6 Stück/Packung.

Roadbed end piece. To finish of the roadbeds properly in the case of track bumpers, display case track etc. 6 units/pack.

Art. Nr.: 42267 € 4,40



Prellbock Bausatz.
Wahlweise mit Holzbohle oder Puffern aufzubauen.
Inhalt 2 Stück.
Track bumper construction kit.
Optionally with wood plank or bumpers. 2 units/pack.

geoline GLEISE / TRACKS

Gebogene Gleise / Curved tracks

Art. Nr.: 61122 € 2,80



Bogengleis R2, 30°, Radius = 358 mm.
Curved track R2, 30°, radius = 358 mm.

Art. Nr.: 61123 € 2,90



Bogengleis R3, 30°, Radius = 434,5 mm.
Curved track R3, 30°, radius = 434,5 mm.

Art. Nr.: 61124 € 3,40



Bogengleis R4, 30°, Radius = 511,1 mm.
Curved track R4, 30°, radius = 511,1 mm.

Art. Nr.: 61128 € 2,90



Bogengleis GB2, Radius 502,7 mm,
Gegenbogen zu 22,5°-Weichen 61140/61141.
Curved track GB2, radius 502,7 mm, complementary curve to 22,5° turnouts 61140/61141.

Art. Nr.: 61129 € 2,80



Bogengleis R2, 7,5°, Radius = 358 mm.
Curved track R2, 7,5°, radius = 358 mm.

Art. Nr.: 61130 € 2,80



Bogengleis R3, 7,5°, Radius = 434,5 mm.
Curved track R3, 7,5°, radius = 434,5 mm.

Die Gleisradien:

Der Abstand beträgt 76,5 mm, so dass auch lange Fahrzeuge bei Zugbegegnungen in der Kurve sich nicht berühren.

The track radii:

The distance is 76.5 mm so that even longer vehicles do not touch when trains enter curves

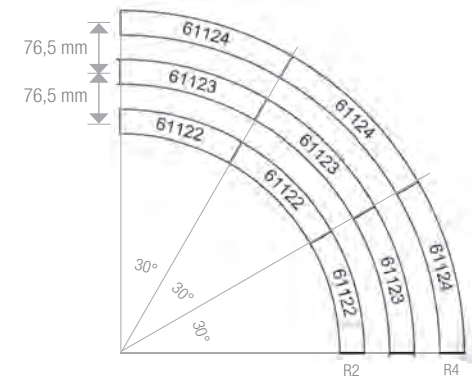

Bogenweichen Curved points

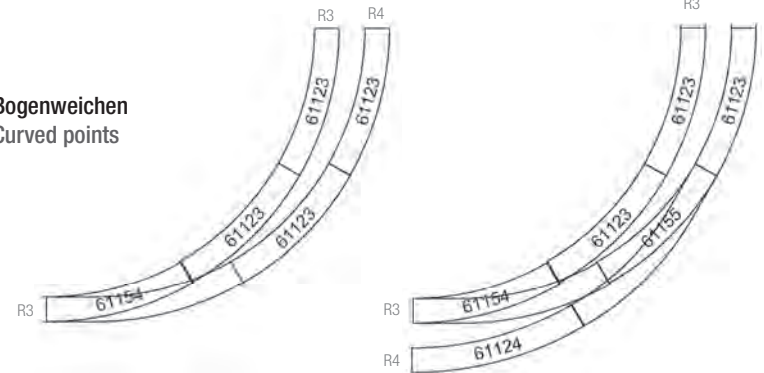

Gegenbogen 61128 für gerade Weichen, Dreiweg- und Kreuzungsweiche:

Opposite curve 61128 for straight points, threeway-point and double-slip:

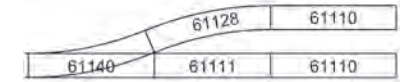

Elektr. Zubehör Electrical accessory



Art. Nr.: 61191 € 5,70

Stromeinspeisungselement für Analogbetrieb DC. Das Element kann an jeder Geraden oder jedem Bogen an den dafür vorgesehenen Stellen eingesetzt werden. **Nicht für Digitalbetrieb geeignet.**
Feed-in power element for analogue DC operation. It can be connected to any straight or curved track at a point defined in the factory. **Not suitable for digital operation.**

Art. Nr.: 61190 € 5,70

Stromeinspeisungselement für Digitalbetrieb DCC. Das Element kann an jeder Geraden oder jedem Bogen an den dafür vorgesehenen Stellen eingesetzt werden.
Feed-in power element for digital DCC operation. It can be connected to any straight or curved track at a point defined in the factory.

Weichen / Points

Art. Nr.: 61140 € 21,40



Handweiche links, Länge 200 mm (= Länge Standardgerade),
Abzweigwinkel 22,5°, Abzweigradius 502,7 mm

Turnout left, length 200 mm (= length of standard track),
branch angle 22,5°, branch radius 502,7 mm

Art. Nr.: 61141 € 21,40



Handweiche rechts, Länge 200 mm (= Länge Standardgerade),
Abzweigwinkel 22,5°, Abzweigradius 502,7 mm

Turnout right, length: 200 mm (= Length of standard track),
branch angle 22,5°, branch radius 502,7 mm

Art. Nr.: 61154 € 33,40



Bogenweiche links R 3/4, 30°, Radius des Stamm-
gleises und des Abzweiggleises 434,5 mm.

Curved turnout left R 3/4, 30°, radius of the main
track and the branch line 434,5 mm.

Art. Nr.: 61155 € 33,40

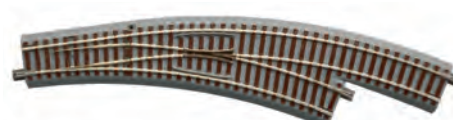

Bogenweiche rechts R 3/4, 30°, Radius des
Stammgleises und des Abzweiggleises 434,5 mm.

Curved turnout right R 3/4, 30°, radius of the main
track and the branch line 434,5 mm.

Art. Nr.: 61160 € 46,90



Dreiwegweiche, Länge 200 mm (= Länge Standardgerade),
Abzweigwinkel je 22,5°, symmetrisch

Three-way turnout, length 200 mm (= length of standard track),
branch angle 22,5° each, symmetrical

Art. Nr.: 61164 € 51,90



Doppelkreuzungsweiche, 22,5°, Länge 200 mm (= Länge
Standardgerade)

Double slip, 22,5°, left hand crossing, length 200 mm (= length
of standard track)

Normalweichen:
Standard points:

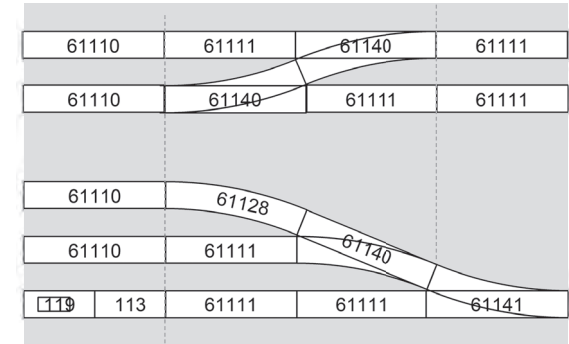

Dreiweg-Weichen
Kreuzungsweichen:
Threeway points
Double slip:

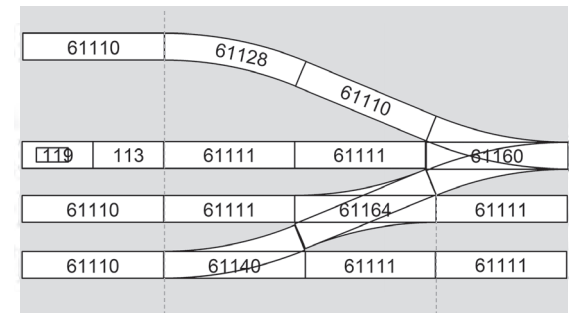

Elektr. Zubehör / Electrical accessory

Art. Nr.: 61195 € 21,90



Universalweichenantrieb elektrisch, zum nachträglichen Umrüsten von
allen geoLine Weichen von Handbetrieb auf elektrischen Betrieb.

General purpose turnout mechanism, to convert each geoLine turnout
from manual operation to electrical operation.

Zubehör / Accessories

Art. Nr.: 61192 € 4,30



**Isolierschienenverbinder mit Universalwerk-
zeug**. Packungsinhalt: 28 Stück Isolierschienen-
verbinder.

Insulated rail connector with universal tool. 28
units/pack.

Vom StarterSet zum Wunderland! From StarterSet to wonderland!



Basteln, Bauen & Tüfteln – Roco bietet für jeden die passenden Produkte, sei es für den Start in die Welt der kleinen Eisenbahnen oder für den perfekten Ausbau des Profis. Egal, ob als Spielanlage auf dem Boden oder als dauerhaft aufgebaute Modellbahnanlage, das gemeinsame Spielen mit der Bahn verbindet Jung und Alt. Der Wunsch, Lokführer zu werden, kann bei Roco in drei Modellbahn-Baugrößen realisiert werden; in H0, H0e oder TT.

Jedes Starter Set ist eine komplette, spielfertige Anlage mit Lok und Wagen, vielen Gleisen und einem Steuergerät. Mit Gleis-Sets kann man systematisch das Starter Set Schritt für Schritt bis hin zu einer großen Modellbahnanlage erweitern. Mit passendem Zubehör wird daraus schnell eine spektakuläre Modellbahnanlage

Handicraft work, building & tinkering - Roco offers the right products for everyone, whether it be for the start in the world of small railways or for the perfect development of the professionals. No matter, whether it be as a play layout on the floor or as a large model railway layout for permanent use, the shared play fun connects young and old. The wish to become a train driver can be fulfilled in three Roco model train scales: in H0, H0e or TT. Each starter kit is a complete, ready-to-play layout with locomotive and cars, many tracks and a control unit. The starter-kit can be systematically extended step by step until it reaches a large size railway layout. With the matching accessories it will quickly develop into a spectacular layout.



Anlagenfotos von / Layout pictures by:



Im Miniatur Wunderland Hamburg können Sie sich einen überwältigenden Einblick in die Welt der Modellbahn verschaffen.

In the Miniature Wonderland Hamburg, you can get a stunning insight into the world of model trains.



Impressum / Imprint

Herausgeber / Published by:

Modelleisenbahn München GmbH, Kronstadter Str. 4, 81667 München, Deutschland
www.roco.cc

Preise / Price indication:

Bei den im Prospekt angegebenen Preisen handelt es sich um die zum Zeitpunkt der Drucklegung gültige unverbindliche Preisempfehlung des Herstellers. Wir behalten uns ausdrücklich jederzeitige Preisanpassungen vor. Roco Produkte und Ersatzteile werden über den Modellbahnfachhandel sowie im eigenen e-Shop vertrieben.

The prices specified in this folder are the manufacturer's suggested retail prices at the time the folder went to press. We explicitly reserve the right to make price adjustments at any time. Roco products and spare parts are available through specialized dealers and online at www.roco.cc.

Bildnachweise / photo credits:

Modelleisenbahn München GmbH, M. Zirn, S. Zenzmaier, bluforce group, Siemens, Fotolia, Fleischmann-Archiv, Georg Dahlhoff Fotografie sowie bei den Bildern angegebene Fotografen.

Druck und Verarbeitung / printing and processing:

Druckerei Berger, Ferdinand Berger & Söhne GmbH, Wiener Straße 80, 3580 Horn

Haftung / Liability:

Dieser Prospekt ist mit hoher Qualität und Sorgfalt erstellt. Es wird aber keine Haftung für die Richtigkeit sowie Vollständigkeit der Inhalte übernommen. Für eventuelle Schäden materieller oder ideeller Art durch Nutzung, Nichtnutzung oder Vorenthaltung von fehlerhaften oder unvollständigen Informationen in diesem Prospekt – soweit sie nicht durch nachweislichen Vorsatz oder nachweisliche grobe Fahrlässigkeit seitens der Modelleisenbahn München GmbH begründet sind – kann keinerlei Gewähr und Haftung übernommen werden. Wir behalten es uns vor, jederzeit die Inhalte des Prospektes sowie die technischen Eigenschaften der darin enthaltenen Produkte zu aktualisieren. Die Wiedergabe von Warenzeichnungen, Marken, Handelsnamen oder Firmenbezeichnungen und sonstigen Kennzeichen in diesem Neuheitenprospekt berechtigt nicht zu der Annahme, dass diese von jedermann frei benutzt werden dürfen. Vielmehr kann es sich auch dann um eingetragene Marken oder sonstige gesetzlich geschützte Kennzeichen handeln, wenn sie nicht als solche markiert sind. Viele Abbildungen zeigen Handmuster. Die endgültige und gelieferte Ausführung der Modelle kann deshalb von den gezeigten Bildern abweichen.

We strive to provide the content of this folder with the highest quality. Despite of our best effort and the best possible care Modelleisenbahn München GmbH is not liable and gives no warranty for the accuracy, the up-to-dateness or completeness of the contents and the information given in this folder. For eventual damages of material or ideal nature that result from the use, the non-use or the withholding of faulty or incomplete information in this folder - as far as it is not founded in demonstrable intent and negligence on part of the Modelleisenbahn München GmbH - no guarantee or liability can be given. We furthermore reserve the right to update the contents of the folder as well as the technical specifications of the contained products at any time. The copying of the identifications, trade brands, trade names or company names and other characteristics in this folder does not justify the assumption that those can be used by everybody free of charge. It can rather be that it is a registered trademark or characteristics otherwise protected by law even if these are not specifically marked up as such.

Symbole der Bahnverwaltungen

Symbols of railway operators

(Nicht alle kommen in diesem Folder vor) / Not all appear in this folder

	Österreichische Bundesbahnen (ÖBB) – nach dem 2. Weltkrieg Austrian Federal Railways (ÖBB) – after World War II
	Nationale Gesellschaft der belgischen Eisenbahnen National Railway Company of Belgium (SNCB/NMBS)
	Schweizerische Bundesbahnen Swiss Federal Railways (SBB, CFF, FFS)
	Lötschbergbahn AG Private Bahngesellschaft Private Railway company
	Königl. Preußische Eisenbahn-Verwaltung (K.P.E.V.) Royal Prussian Railway Administration (K.P.E.V.)
	Königliche Bayerische Staatseisenbahn Royal Bavarian State Railways
	Deutsche Reichsbahn (Gesellschaft) (bis 1945) DRG/DRB German Reich Railway Company (up until 1945), DRG, DRB
	Deutsche Reichsbahn (nach 1945) DR German Reich Railway (starting 1945), DR
	Deutsche Reichsbahn (ab etwa 1968) German Reich Railway (approx. since 1968)
	Deutsche Bundesbahn (1951-1993)
	Deutsche Bahn AG (seit 1.1.1994)
	Dänische Staatsbahnen Danish State Railways
	Spanische Staatsbahn Spanish Railways
	Nationale Gesellschaft der französischen Eisenbahnen National French Railways (SNCF)
	Ungarische Staatsbahn Hungarian Railways (MÁV)
	Italienische Staatsbahn Italian State Railways
	Norwegische Staatsbahn Norwegian State Railways
	Niederländische Staatsbahn Dutch Railways
	Polnische Staatsbahn Polish State Railways
	Schwedische Staatsbahn Swedish State Railways
	Privates Eisenbahnverkehrsunternehmen Private Railway Companies

	Österreich, Austria (A)		Spanien, Spain (E)		Niederlande, Netherlands (NL)
	Belgien, Belgium (B)		Frankreich, France (F)		Polen, Poland (PL)
	Schweiz, Switzerland (CH)		Ungarn, Hungary (H)		Schweden, Sweden (S)
	Deutschland, Germany (D)		Italien, Italy (I)		
	Dänemark, Denmark (DK)		Norwegen, Norway (N)		